

**PLANAR** | [www.planar.com](http://www.planar.com)

# Planar LCD Monitor



## CT1744NU Manual





---

**PREFACE**

---

**About this manual**

---

This manual is designed to assist you in setting up and using the LCD monitor. Information in this document has been carefully checked for accuracy; however, no guarantee is given to the correctness of the contents. The information in this document is subject to change without notice. This document contains proprietary information protected by copyright. All rights are reserved. No part of this manual may be reproduced by any mechanical, electronic or other means, in any form, without prior written permission of the manufacturer.

**Copyright**

© Copyright 2001, All Rights Reserved

---

**FCC Compliance Statement**

---

This device complies with part 15 of the FCC Rules. Operation is subject to the following two conditions:

1. this device may not cause harmful interference, and
2. this device must accept any interference received, including interference that may cause undesired operation.

**FCC WARNING**

This equipment has been tested and found to comply with the limits for a Class B digital device, pursuant to Part 15 of the FCC Rules. These limits are designed to provide reasonable protection against harmful interference in a residential installation.

This equipment generates, uses and can radiate radio frequency energy and, if not installed and used in accordance with the instructions, may cause harmful interference to radio communications.

However, there is no guarantee that interference will not occur in a particular installation. If this equipment does cause harmful interference to radio or television reception, which can be determined by turning the equipment off and on, the user is encouraged to try to correct the interference by one or more of the following measures:

- Reorient or relocate the receiving antenna.
- Increase the separation between the equipment and the receiver.
- Connect the equipment into an outlet different from that to which the receiver is connected.
- Consult the dealer or an experienced radio/TV technician for help.

**Caution:**

To comply with the limits for an FCC Class B computing device, always use the shielded signal cord supplied with this unit.

The Federal Communications Commission warns that changes or modifications of the unit not expressly approved by the party responsible for compliance could void the user's authority to operate the equipment.

---

**CE mark for Class B ITE (Following European standard EN55022/1998; EN61000-3-2/1995; EN61000-3-3/1995, EN55024/1998, EN60950/1992+A1+A2+A3+A4+A11)**

---

---

**Radio Frequency Interference Statement**

---

**Warning:**

This is a Class B product. In a domestic environment, this product may cause radio interference in which case the user may be required to take adequate measures.



---

## Canadian Doc Notice

---

### For Class B Computing Devices

This digital apparatus does not exceed the Class B limits for radio noise emissions from digital apparatus as set out in the Radio Interference Regulation of the Canadian Department of Communications.

“Le présent appareil numérique n’émet pas de bruits radioélectriques dépassant les limites applicables aux appareils numériques de la class B prescrites dans le Règlement sur le brouillage radioélectrique édicté par le ministère des Communications du Canada”

### Important Operating Instructions

---

Please read the following instructions carefully. This manual should be retained for future use.

1. To clean the LCD monitor screen, first, make sure the monitor is in the power off mode. Unplug the monitor from its power source before cleaning it. Do not spray liquid cleaners directly onto the unit. Without applying excessive pressure, clean the screen with a slightly dampened rag.
2. Do not place your LCD monitor near a window. Exposing the monitor to rain, water, moisture, or sunlight can severely damage it.
3. Do not place anything on top of the monitor-to-PC signal cord. Make sure the cord is placed in an area where it will not be stepped on.
4. Do not apply pressure to the LCD screen. Excessive pressure may cause permanent damage to the display.
5. Do not remove the cover or attempt to service this unit by yourself. You may void the warranty. Servicing of any nature should be performed only by an authorized technician.
6. Safe storage of the LCD monitor is in a range of minus 20 to plus 60 degrees Celsius. Storing your LCD monitor outside this range could result in permanent damage.
7. Only with use of supplied adapter, in case of loss or replacement contact the retailer or service center.
8. Immediately unplug your monitor and call an authorized technician when:
  - The power or monitor-to-PC signal cord is frayed or damaged.
  - Liquid has been spilled into the monitor, or it has been exposed to rain.
  - The monitor has been dropped or the case has been damaged.



# Table of Contents

**PREFACE** ..... I

**CHAPTER 1**..... 1

**Your New Planar LCD Monitor!**..... 1

**Unpacking**..... 1

**Identifying Components** ..... 1

*The LCD Monitor — Front View*..... 1

*The LCD Monitor — Rear View*..... 2

**Adjusting the Viewing Angle**..... 3

**Connecting AC Power** ..... 3

**Connecting Video**..... 3

**Connecting the Stereo Speakers**..... 4

**Power Management System**..... 4

**CHAPTER 2**..... 6

**Your New Planar LCD Monitor’s Display Controls** ..... 6

**Adjusting the Monitor’s Display** ..... 6

**OSD Main Menu (Analog mode)**..... 6

**OSD Main Menu (Digital mode)**..... 9

**APPENDIX A**..... 12

**TFT LCD Monitor Specifications**..... 12

**APPENDIX B**..... 13

**APPENDIX C**..... 14

**Troubleshooting Procedures** ..... 14



## Your New Planar LCD Monitor!

Your LCD monitor has been designed to be versatile, ergonomic, and easy to use. The LCD monitor is capable of displaying most standards, from 640 x 480 VGA to 1280 x 1024 SXGA. The digital controls located on the front panel allow you to easily adjust the monitor's display parameters. The LCD monitor has the additional feature of a VESA arm-mounted interface for added convenience.

## Unpacking

After you unpack your LCD monitor, make sure the following items are included in the box and in good condition:

### Standard Items

- LCD Monitor
- Monitor-to-PC signal cable (15-pin)
- Monitor-to-PC Digital signal cable (24-pin)
- USB cable (optional)
- Stereo Jack Audio Cable
- Power cord
- AC/DC adapter
- This user's manual

If you find that any of these items are missing or appear damaged, contact your dealer immediately. Do not throw away the packing material or shipping carton in case you need to ship or store the LCD monitor in the future.

## Identifying Components

The following figures will help you identify the LCD monitor's controls and ports.

### The LCD Monitor — Front View

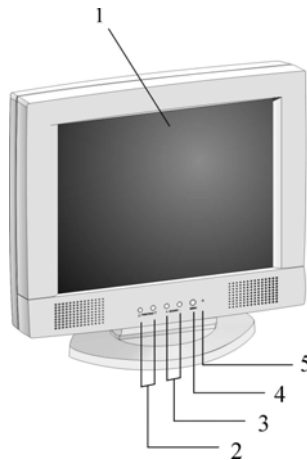



## 1. Display Module

The display is a 17.4" diagonal, Active Matrix Liquid Crystal Display (AMLCD). The screen is capable of supporting a maximum resolution of 1280 x 1024 (SXGA).

## 2. ◀Function▶ Select Buttons

These two buttons allow you to select the control functions in the OSD. Press either button to scroll horizontally through the main menu and submenu items.

## 3. ⊖ Adjust ⊕ Control Buttons

The ⊕ button allows you to increase the menu item value.  
The ⊖ button allows you to decrease the menu item value.

## 4. Menu

Push the Menu select button activates the On Screen Display (OSD).

## 5. LED Power Mode Indicator

This LED indicator stays lit when the power is on and when the monitor is receiving a proper video signal. The LED will blink slowly when the LCD monitor is in power saving mode.

## The LCD Monitor — Rear View

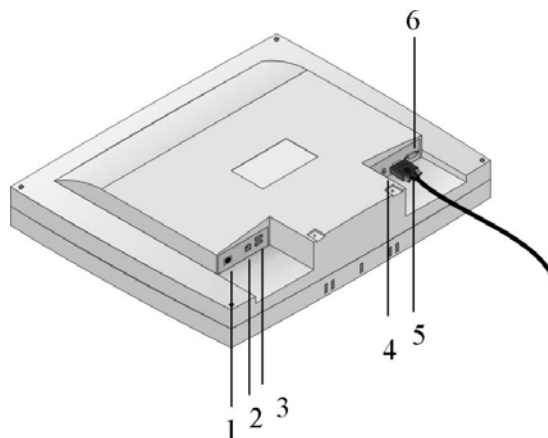

### 1. DC Power Jack for AC adaptor

Connect the AC adapter cable to this jack.

### 2. Upstream USB Port (optional)

Connect the LCD monitor's upstream USB port to your PC's USB port.

### 3. Downstream USB Ports (optional)

The monitor's two downstream USB ports let the LCD monitor function as a USB hub allowing the connection of USB compliant devices. The upstream USB port must be connected to your PC for the downstream ports to function.

### 4. Audio Line-in (optional)

Connect your PC's line-out to this jack to listen the PC's audio on the LCD monitor's stereo speakers. (You can also connect your CD-ROM's line-out to this jack.)

### 5. VGA Cable Connector

This 15-pin D-Sub VGA connector is used to connect to your PC's VGA card.

### 6. Digital VGA Cable Connect (optional)

This 24-pin DVI connect is used to connect to you PC's Graphic card which has a DVI connector





## Adjusting the Viewing Angle

Your LCD Monitor is designed to allow you to adjust it to a comfortable viewing angle. The LCD Monitor's angle setting range is from  $-5^{\circ}$  to  $15^{\circ}$ .

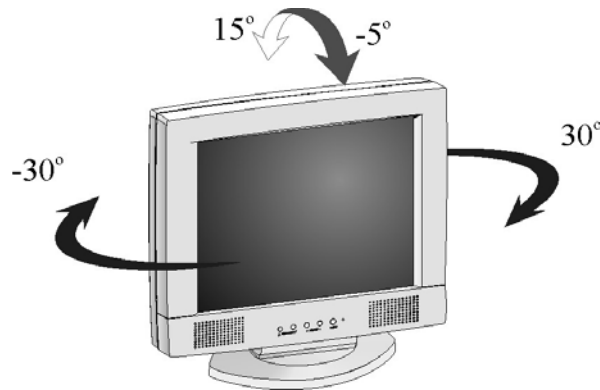

## Connecting AC Power

1. Plug the female end of the power cable into the AC-adaptor. Plug the male end of the power cord into a wall socket. The plug on the power cable will vary according to the electrical standard in your area.

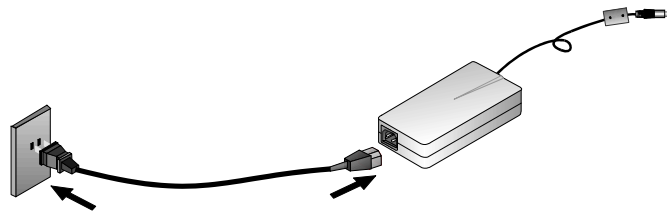

2. Connect the power connector of the adapter into the jack of the LCD Monitor. The AC power jack is located at the rear of the Monitor near the D-sub VGA connector.

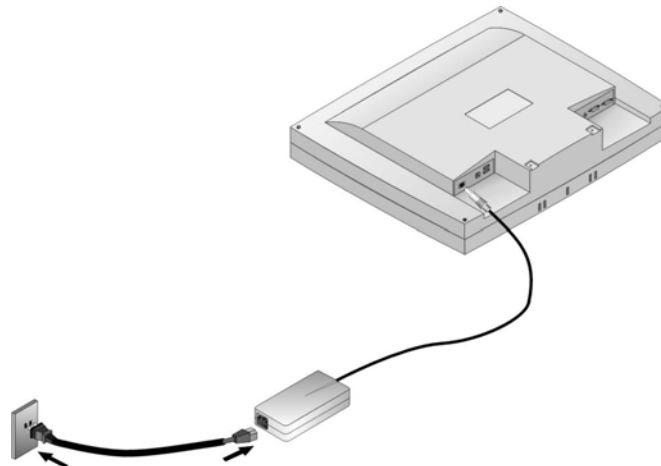

## Connecting Video

1. Turn off your PC and the LCD Monitor before connecting your LCD
2. Monitor to the computer.
3. Connect the VGA signal cable to the D-sub VGA connector located at the rear of the monitor.
4. PC has a graphic card with a 24-pin DVI connector, you should connect it with the Digital 24-pin DVI signal cable.

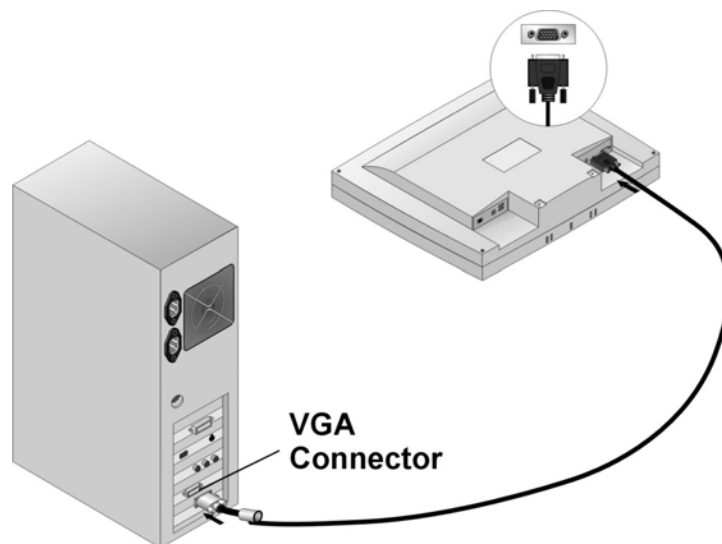

5. Make sure the signal cable heads are securely connected to the VGA ports of your PC and Monitor. Tighten the connecting screws to ensure a secure connection.
6. Turn on your computer and LCD Monitor.

## Connecting the Stereo Speakers

Please refer to the following instructions for connecting the LCD Monitor's stereo speakers.

1. Connect the 1.5M sound cable to the Lineout of your PC's audio card.
2. Connect the other end of the 1.5M sound cable to the LCD Monitor's line-in jack.

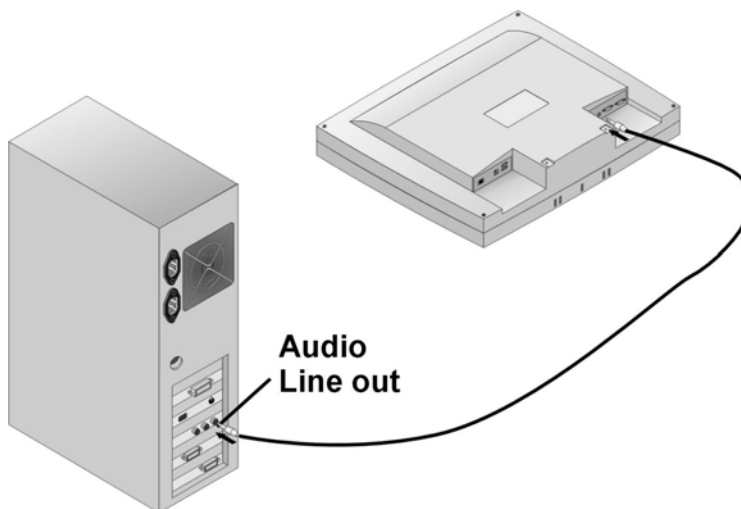

3. You can adjust the sound volume of the stereo speakers by using the speaker volume control function on the OSD (On-Screen Display).

## Power Management System

The LCD monitor complies with the VESA DPMS power management proposal. The VESA DPMS proposal provides power saving modes by detecting the horizontal or vertical sync signal.

When the LCD monitor is in power saving mode or detects an incorrect timing, the monitor screen will be blank and the power LED indicator starts blinking.

## Your New Planar LCD Monitor's Display Controls

This chapter covers your New Planar LCD Monitor's On Screen Display (OSD). Using the OSD, you can adjust the contrast, brightness, display position, display clarity, and color temperature. You can also adjust the stereo speaker volume and set OSD parameters. Please read this chapter carefully to get the most out of your New Planar LCD Monitor.

### Adjusting the Monitor's Display

The LCD monitor features an intuitive, menu-driven, On-Screen Display (OSD). You can access the OSD any time that the PC is powered up. If the PC is in a power saving mode, or is powered down, the OSD is inaccessible.

◀FUNCTION▶                      – ADJUST +                      POWER

### OSD Main Menu (Analog mode)



To activate the OSD Main Menu, press the ◀ Function key. To navigate the topline menu, use either the right ▶ or left ◀ Function keys to scroll between the main menu choices.

The option that is currently selected is highlighted in yellow and indicated by a pointer. Each main menu has an associated submenu and is further described.

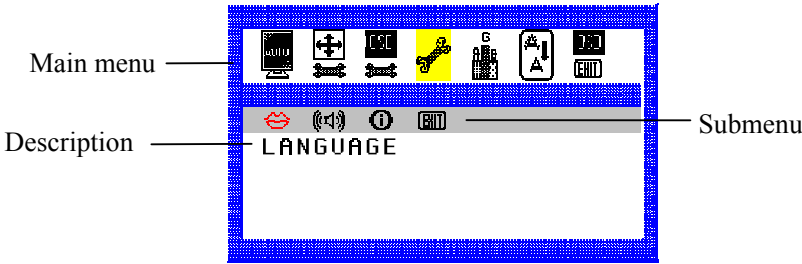

To access the OSD Main Menu, simply press the ◀ *Function* button. The following screen will appear.

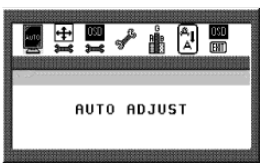



The 7-topline menus are:



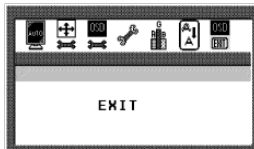





	<p>The Auto Adjust option lets the monitor determine and select the settings that are most appropriate for your system requirements. This function will tune the display to your computers video card.</p>
	<p>The Monitor-Control option allows you to adjust the LCD monitor's display characteristics such as the display's horizontal or vertical position, display phase, display clock, and factory reset. Adjusting these settings should only be necessary if the results from Auto-Adjust function are not satisfactory.</p>
	<p>The OSD-Control option allows you to adjust the position and setting of the monitor's On Screen Display.</p>







	<p>The MISC-Control option allows you to select the desired text language of the OSD, adjust the monitor speaker volume, and to display the current video information being sent to the monitor from your video card.</p>
	<p>The Graphic-Control option allows you to adjust the display contrast, brightness, sharpness, and color settings.</p>
	<p>The Graph/Tex option allows you to switch DOS text resolution from 640x400 and 720x400. This function has no effect within graphic operating systems such as MS Windows™.</p>
	<p>The OSD Exit option closes the On Screen Display.</p>





**Main Functions:**





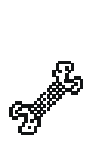



		<p><b><u>Auto Adjust Procedure</u></b></p>
<p>Pressing the Adjust ⊕ key while the Auto Adjust topline menu is selected, activates the Auto Adjust procedure. The Auto Adjust procedure takes approximately 2 seconds to complete. Once finished, the OSD menu will disappear after a short time-out period.</p>		

		<p><b><u>The Monitor- Control Option</u></b></p>
<p>Pressing the Adjust ⊕ key while the Monitor Control icon is selected activates the Monitor Control submenu. Use the ◀Function▶ select buttons to scroll between the submenu items. You should only use this menu item if the results of the Auto Adjust function are not satisfactory.</p>		
	<p><b>H-Position:</b> Press the ⊖ Adjust ⊕ buttons to horizontally move the display image to the desired position.</p>	
	<p><b>V-Position:</b> Press the ⊖ Adjust ⊕ buttons to vertically move the display image to the desired position.</p>	
	<p><b>Phase:</b> Press the ⊖ Adjust ⊕ buttons to fine-tune the displayed image. An improper phase adjustment will result in pixel jitter or display noise.</p>	
	<p><b>Clock:</b> Press the ⊖ Adjust ⊕ buttons to stabilize the display clock timing. An improper clock setting will result in wide vertical bands on the display.</p>	
	<p><b>Reset:</b> Press the Adjust ⊕ button to reset the Monitor-Control submenu values to the factory default values.</p>	
	<p><b>Port-Select:</b> Press the Adjust sbuttons to change input VGA port</p>	
	<p><b>Exit:</b> Press the Adjust ⊕ button key to exit the Monitor-Control submenu.</p>	



		<h3><u>OSD - Control Option</u></h3>
<p>Pressing the Adjust <math>\oplus</math> key while the OSD Control icon is selected activates the OSD Control submenu. Use the <b>◀Function▶</b> select buttons to scroll between the submenu items.</p>		
	<p><b>OSD-H-Position:</b> Press the <math>\ominus</math> Adjust <math>\oplus</math> buttons to horizontally move the OSD menu.</p>	
	<p><b>OSD-V-Position:</b> Press the <math>\ominus</math> Adjust <math>\oplus</math> buttons to vertically move the OSD menu.</p>	
	<p><b>Exit:</b> Press the Adjust <math>\oplus</math> button key to exit the OSD-Control submenu.</p>	

		<h3><u>Misc. - Control Option</u></h3>
<p>Pressing the Adjust <math>\oplus</math> key while the Misc Control icon is selected activates the Misc Control submenu. Use the <b>◀Function▶</b> select buttons to scroll between the submenu items.</p>		
	<p><b>Language:</b> Press the <math>\ominus</math> Adjust <math>\oplus</math> buttons to select the desired OSD display language. Languages supported: English, German, French, Spanish, and Italian.</p>	
	<p><b>Audio Volume:</b> Press the <math>\ominus</math> Adjust <math>\oplus</math> buttons to increase or decrease the volume of the monitor speakers.</p>	
	<p><b>Information:</b> The Information submenu displays the current resolution, vertical refresh rate, and monitor firmware version.</p>	
	<p><b>Exit:</b> Press the Adjust <math>\oplus</math> button to exit the Misc-Control submenu.</p>	

		<h3><u>Graphic Control Option</u></h3>
<p>Pressing the Adjust <math>\oplus</math> key while the Graphic Control icon is selected activates the Graphic Control submenu. Use the <b>◀Function▶</b> select buttons to scroll between the submenu items.</p>		
	<p><b>Contrast:</b> Press the <math>\ominus</math> Adjust <math>\oplus</math> buttons to adjust the difference between the lightest and darkest areas on the display. The contrast level can range from 0 to 63.</p>	
	<p><b>Brightness:</b> Press the <math>\ominus</math> Adjust <math>\oplus</math> buttons to adjust the intensity of the monitor backlight.</p>	
	<p><b>Sharpness:</b> Press the <math>\ominus</math> Adjust <math>\oplus</math> buttons to select the desired sharpness setting.</p>	
	<p><b>Color:</b> Press the <math>\ominus</math> Adjust <math>\oplus</math> buttons to select the desired color temperature setting. The available options are CIE coordinate values 9300°, 6500°. Selecting the USER option, allows for customization of the Red, Green and Blue color coordinates.</p>	
	<p><b>R, G and B:</b> Press the <math>\ominus</math> Adjust <math>\oplus</math> buttons to make individual adjustments to the Red, Green, and Blue coordinates for the customized color temperature. There are 127 levels of adjustments (0 - 127) available.</p>	
	<p>Before adjusting these fields, you must select the User option in the Color submenu.</p>	
	<p><b>Exit:</b> Press the Adjust <math>\oplus</math> button to exit the Graphic-Control submenu.</p>	



		<p><b><u>Graph/Text Option</u></b></p>
<p>Pressing the Adjust  key while the Graph/Text icon is selected toggles the DOS resolution between 640x400 and 720x400.</p>		

		<p><b><u>OSD Exit</u></b></p>
<p>Pressing the Adjust  key while the Exit icon is selected, deactivates the OSD menu.</p>		

## OSD Main Menu (Digital mode)

To access the OSD Main Menu, simply press the *Function* button. The following screen will appear.





### The Digital 5-topline menus are:



	<p>The Monitor-Control option allows you to adjust the LCD monitor's display characteristics such as the display's horizontal or vertical position, display phase, display clock, and factory reset. Adjusting these settings should only be necessary if the results from Auto-Adjust function are not satisfactory.</p>
	<p>The OSD-Control option allows you to adjust the position and setting of the monitor's On Screen Display.</p>
	<p>The MISC-Control option allows you to select the desired text language of the OSD, adjust the monitor speaker volume, and to display the current video information being sent to the monitor from your video card.</p>
	<p>The Graphic-Control option allows you to adjust the display contrast, brightness, sharpness, and color settings.</p>





	<p>The OSD Exit option closes the On Screen Display.</p>
---	--



		<p><b><u>The Monitor- Control Option</u></b></p>
---	---	--



Pressing the Adjust  $\oplus$  key while the Monitor Control icon is selected activates the Monitor Control submenu. Use the **◀Function▶** select buttons to scroll between the submenu items. You should only use this menu item if the results of the Auto Adjust function are not satisfactory.

	<p><b>Port-Select:</b> Press the <math>\ominus</math> Adjust <math>\oplus</math> buttons to change input VGA port</p>
	<p><b>Exit:</b> Press the Adjust <math>\oplus</math> button key to exit the Monitor-Control submenu.</p>





		<p><b><u>OSD - Control Option</u></b></p>
---	---	---



Pressing the Adjust  $\oplus$  key while the OSD Control icon is selected activates the OSD Control submenu. Use the **◀Function▶** select buttons to scroll between the submenu items.

	<p><b>OSD-H-Position:</b> Press the <math>\ominus</math> Adjust <math>\oplus</math> buttons to horizontally move the OSD menu.</p>
	<p><b>OSD-V-Position:</b> Press the <math>\ominus</math> Adjust <math>\oplus</math> buttons to vertically move the OSD menu.</p>
	<p><b>Exit:</b> Press the Adjust <math>\oplus</math> button key to exit the OSD-Control submenu.</p>

		<p><b><u>Misc. - Control Option</u></b></p>
---	---	---

Pressing the Adjust  $\oplus$  key while the Misc Control icon is selected activates the Misc Control submenu. Use the **◀Function▶** select buttons to scroll between the submenu items.

	<p><b>Language:</b> Press the <math>\ominus</math> Adjust <math>\oplus</math> buttons to select the desired OSD display language. Languages supported: English, German, French, Spanish, and Italian.</p>
	<p><b>Audio Volume:</b> Press the <math>\ominus</math> Adjust <math>\oplus</math> buttons to increase or decrease the volume of the monitor speakers.</p>
	<p><b>Information:</b> The Information submenu displays the current resolution, vertical refresh rate, and monitor firmware version.</p>
	<p><b>Exit:</b> Press the Adjust <math>\oplus</math> button to exit the Misc-Control submenu.</p>

		<p><b><u>Graphic Control Option</u></b></p>
---	---	---

Pressing the Adjust  $\oplus$  key while the Graphic Control icon is selected activates the Graphic Control submenu. Use the **◀Function▶** select buttons to scroll between the submenu items.



	<p><b>Contrast:</b> Press the  Adjust  buttons to adjust the difference between the lightest and darkest areas on the display. The contrast level can range from 0 to 63.</p>
	<p><b>Brightness:</b> Press the  Adjust  buttons to adjust the intensity of the monitor backlight.</p>
	<p><b>Exit:</b> Press the Adjust  button to exit the Graphic-Control submenu.</p>

		<p><u>OSD Exit</u></p>
<p>Pressing the Adjust  key while the Exit icon is selected, deactivates the OSD menu.</p>		



# Technical Information

## TFT LCD Monitor Specifications

Model	Planar CT1744NU	
LCD Panel	17.4" SXGA	
Control Functions Power	Software Power switch with LED indicator (Press to turn off, over 1 sec. to turn on)	
On-Screen Display (OSD)	Main Menu	Submenu
	Auto Adjust	
	Monitor Control	Horizontal Position/Vertical Position/Phase/Clock/Reset/Exit
	OSD Control	OSD Horizontal Position/OSD Vertical Position/Exit
	Misc. Control	Language/Audio Volume/Information/Exit
	Graphic Control	Contrast/Brightness/Sharpness/Color/R/G/B/Exit
	Graph/Text	640 x 400/720 x 400
	OSD Exit	
Display Area (mm)	345.6 x 276.48 (17.4 inch diagonal)	
Response Time (Rise+Fall)	25ms typ.	
Contrast Ratio	400:1 typ.	
Brightness	220 cd/m <sup>2</sup> typ.	
Pixel Pitch (mm)	0.27 x 0.27	
Viewing Angle	Horizontal: 80°/80° (L/R), Vertical: 80°/80° (U/D)	
Display Colors	Dithering 16M	
Video Interface	Analog port: VGA Compatible Analog RGB (15-pin D-Sub) Separate Sync. /Composite Digital port: DDWG compliant Single Link Tmds Digital Visual Interface (DVI)	
Scanning Frequency H/V, Hz (Analog mode)	24-80kHz 50-75	
Scanning Frequency H/V, Hz (Digital mode)	30-80kHz 50-75	
Power Management	Meets VESA DPMS	
Power Consumption (ON/OFF, W)	50W (typical)/5W (max.) (Measured from AC inlet)	
Dimensions WxHxD mm	467x 452x242	
Net Weight (Kg) Approx.	7.5	
Power Supply	12V/4.16A, 50W Universal Input AC Adapter (External)	
Options	Wall-mounted bracket, Arm-mounted bracket (VESA Compliance) USB Hub (1 up and 2 down streams), Touch Screen,	
Environment	Operating Temperature: 0 to 40° C Relative Humidity: 10% to 90%	
Audio (Two 1 Watt speakers with amplifier)	Yes	
Regulatory	UL, CSA, TÜV/GS, CE Mark, VCCI, T-Mark, FCC B DoC, TCO '99 (optional), Nordic	

## APPENDIX B

# Supported Timing

### Timing for Model CT1744NU (SXGA Resolution)

Item	Standards	Resolution	Dot Clock (MHz)	Vertical Scanning Frequency (Hz)	Horizontal Scanning Frequency (kHz)	Sync Polarity or composite sync (H/V)	Operating Mode
1	NEC PC98	640x400	25.20	70.15	31.50	-/-	A/D
2	NEC PC98	640x400	21.05	56.42	24.83	-/-	A
3	MAC 13" mode	640x480	30.24	66.67	35.00	-/-	A/D
4	MAC 16" mode	832x624	57.28	74.55	49.73	-/-	A/D
5	MAC 17" mode	1024x768	80.00	75.02	60.24	-/-	A/D
6	VGA	640x350	25.18	70.09	31.47	+/-	A/D
7	VGA	640x400	25.18	70.09	31.47	-/+	A
8	VGA	640x480	25.18	59.94	31.47	-/-	A/D
9	VESA	640x480	31.50	72.81	37.86	-/-	A/D
10	VESA	640x480	31.50	75.00	37.50	-/-	A/D
11	VESA	800x600	36.00	56.25	35.16	+/+	A/D
12	SVGA	800x600	40.00	60.32	37.88	+/+	A/D
13	VESA	800x600	50.00	72.19	48.08	+/+	A/D
14	VESA	800x600	49.50	75.00	46.88	+/+	A/D
15	VGA	720x400	28.32	70.09	31.47	-/+	A
16	XGA	1024x768	65.00	60.00	48.36	-/-	A/D
17	VESA	1024x768	75.00	70.07	56.48	-/-	A/D
18	VESA	1024x768	78.75	75.03	60.02	+/+	A/D
19		1024x768	71.64	66.13	53.96	+/+	A/D
20	VESA	1152x864	108.00	75.00	67.50	+/+	A/D
21		1152x870	100	75.06	68.68	-/-	A/D
22	VESA	1280x960	108.0	60.0	60.0	+/+	A/D
23	VESA	1280x1024	108.0	60.02	63.98	+/+	A/D
24	VESA	1280x1024	127.0	69.85	74.88	+/+	A/D
25	VESA	1280x1024	135.0	75.03	79.98	+/+	A/D
26	SUN	1024x768	64.13	59.98	48.29	H+V	A
27	SUN	1024x768	74.25	70.04	56.59	H+V	A

\*A=Analog Mode; D=Digital Mode

\*Once a mode is optimized, there is no need to make any further adjustment as long as the VGA card remains unchanged.

\*Specifications are subject to change without notice.

## Troubleshooting Procedures

This LCD monitor comes pre-adjusted with standard VGA timing. Due to output timing differences among various VGA cards, you may initially experience an unstable or unclear display when a new display mode or new VGA card is selected.

Before applying any of the following troubleshooting procedures, you should first apply the Auto Adjust option in the OSD menu.



*This LCD Monitor Supports Multiple VGA Modes. Refer to Addendum for a listing of the factory-preset modes supported by this LCD Monitor.*

---

---

### **PROBLEM: Display is Unclear and Unstable**

---

---

To stabilize and clarify your display, follow this procedure:

1. In Windows, load a wallpaper bitmap that has vertical lines in it.
2. After the wallpaper has loaded, open the OSD and select the Clock function. Press one of the Adjustment Control buttons until you see vertical dark and light lines across the screen.
3. When you can see distinct light and dark vertical bands, stop pressing the Adjustment Control button. Now press the other Adjustment Control button. The vertical dark and light bands will decrease in number. Keep pressing the button until the distinct bands disappear.
4. Select the Phase function and press one of the Adjustment Control buttons until horizontal dark and light lines appear. The number of lines increases as you press the button. Press the other Adjustment Control button until the lines disappear and you have a clear display.

---

---

### **PROBLEM: There is no LCD Display**

---

---

If there is no display on the LCD, refer to the following:

1. Make sure that the power indicator on the LCD monitor is lit, all connections are secure, and the system is running on the correct timing. Refer to the Addendum for information on timing.
2. Turn off the LCD monitor and then turn it back on again. Press the OSD Menu button (refer to Chapter 2) once and then press either Adjustment Control button several times. If there is still no display, press the other Adjustment Control button several times.
3. If step 2 doesn't work, connect your PC system to another external CRT. If your PC system functions properly with a CRT monitor but it does not function with the LCD monitor, and the LCD monitor's power LED is blinking, the output timing of the PC's VGA card may be out of the LCD's synchronous range. Change to one of the alternate modes, listed in the Addendum, or replace the VGA card and repeat steps 1 and 2.
4. If the PC doesn't function with the CRT monitor either, check your system BIOS to see if there is a dual scan setting under the display mode item. Set the BIOS display mode to *Dual Scan* or *CRT* and try again. If there is still no display, then there may be a problem with your system and you should contact a qualified technician.
5. If the power LED is not lit, check that the AC power connector is securely connected. Verify that the AC adapter LED is lit. If the AC adapter LED is not lit, please contact your dealer for assistance.